

Article number: 204260M10100A1SK

Description: E+G levelling foot
GN 42-60-M10-100-A1-SK

Note: SK With nut, External hexagon at the bottom

Measures

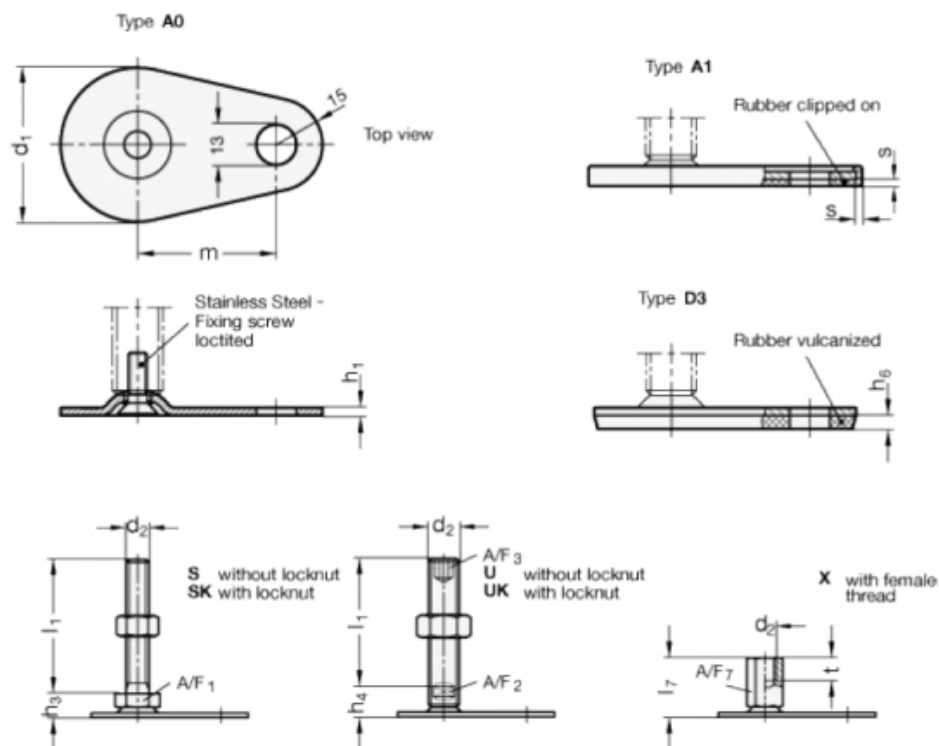

A/F1 = 17	s = 2
d1 = 60	
d2 = M10	
h1 = 2.5	
h3 = 11	
h6 =	
l1 = 100	
m = 50	